

TABLE SELF

Matière : HPL

Ref : ASF-HPL



Adulte



6



**** m

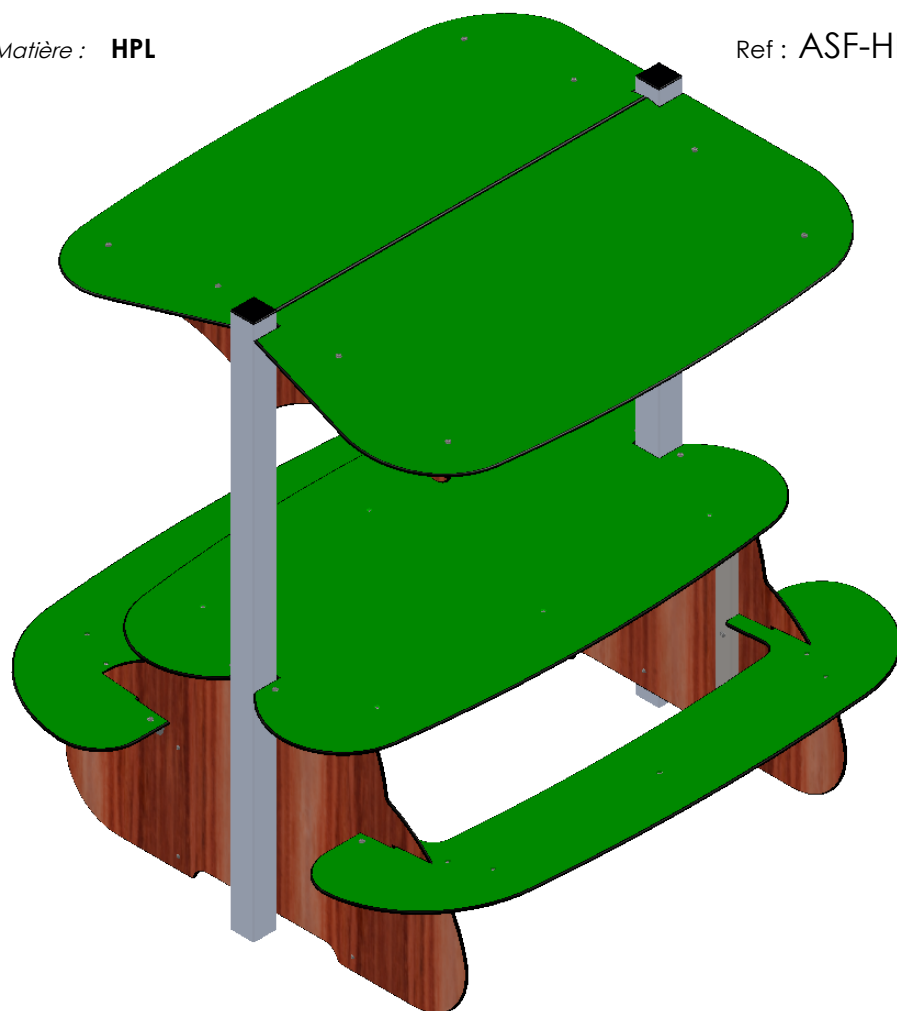

Encombrement du jeu: L 211.90 h 2 m

Fonctions ludiques du jeu

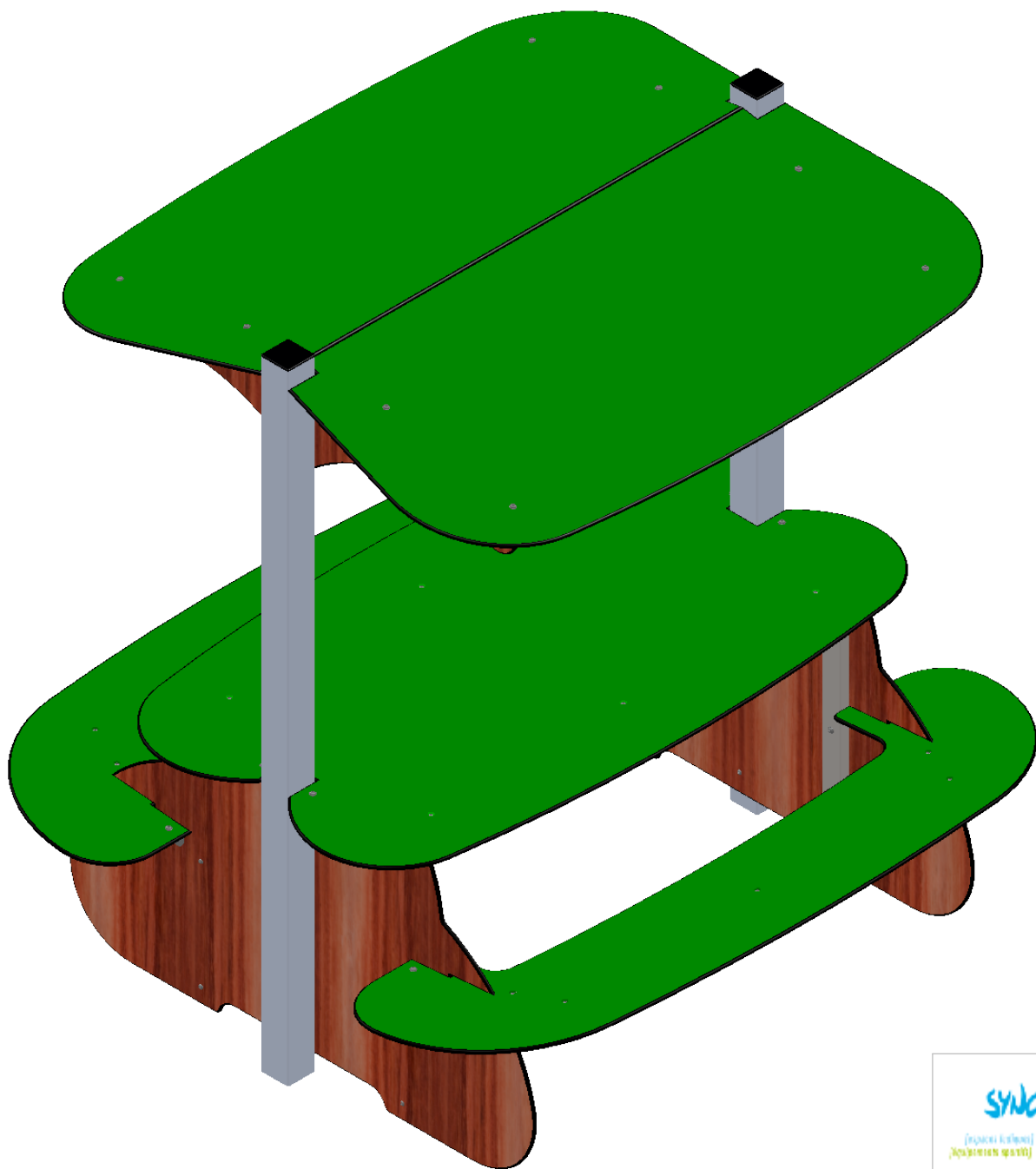

No. ARTICLE	N° DE SERIE PIECE	NUMERO DE PIECE	QTE
1	MO-076	ADJ CHASSIS BANC	2
2	MO-073	ADJ CHASSIS TABLE A SPITER	2
3	MO-077	ADJ banc	2
4	MO-399	ASF PIED TABLE	2
5	P-4110	ASF POTEAU ALU A CHEVILLER	2
6	MO-400	ASF SUPPORT TOIT	2
7	MO-398	ASF TABLE	1
8	MO-401	ASF TOIT	2
9	QR-011	ECROU RELIEUR M8 L11	56
10	Q-027	INSERT 60x30	4
11	QV-149	TBHC M8X12	28
12	QV-007	TBHC M8X35	28
13	QV-008	TBHC M8X40	12
14	Q-005	chapeau poteau 90x90 alu	2
15	Q-008	cornière 35x35	16

	<i>Désignation :</i> TABLE SELF		<i>Matière :</i> HPL	
	<i>Référence :</i> ASF-HPL		<i>Finition :</i>	
<i>Date :</i> 31/08/2021	<i>Dessinateur :</i> MIOTES François		<i>Echelle :</i>	A4

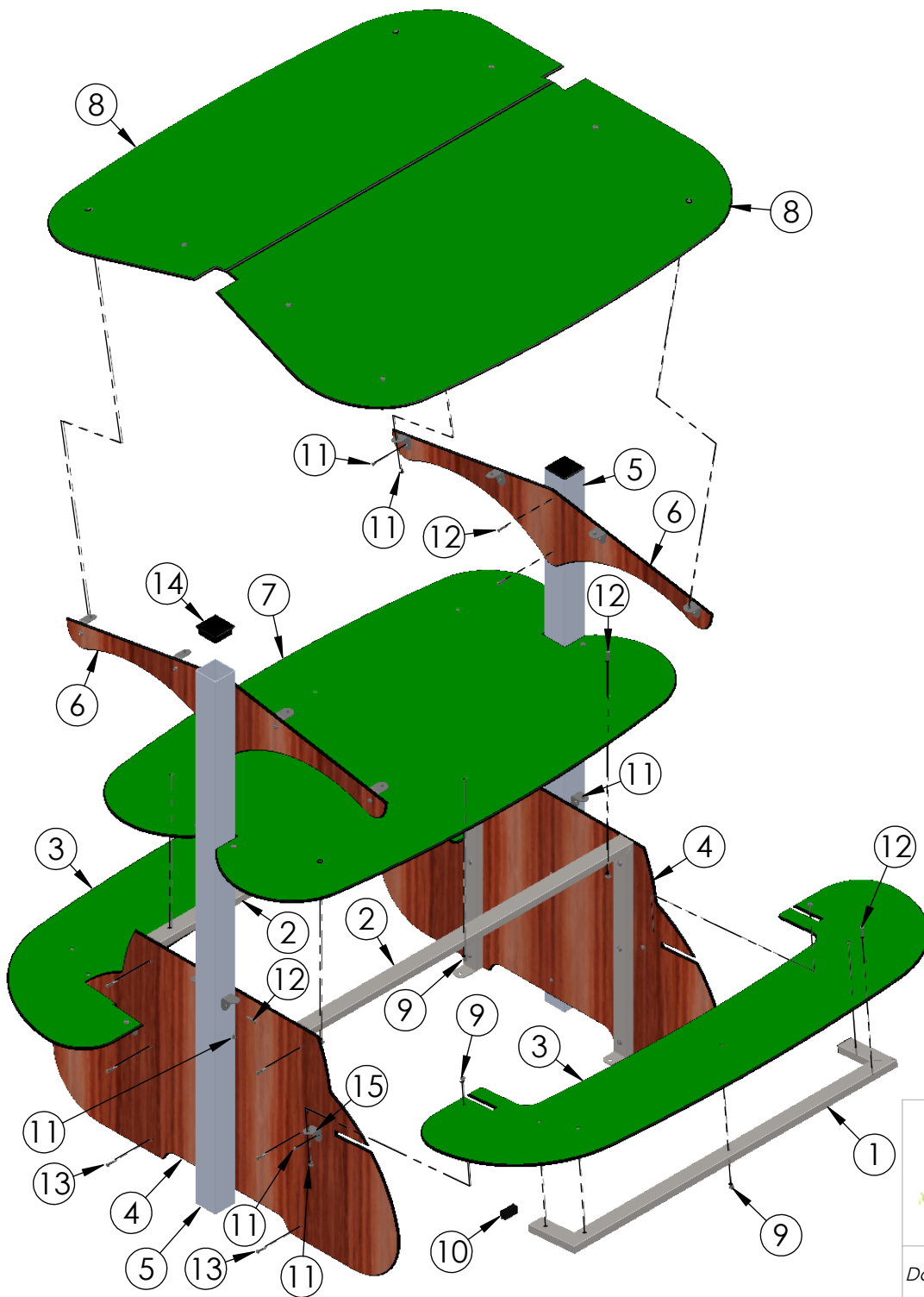

No. ARTICLE	N° DE SERIE PIECE	NUMERO DE PIECE	QTE
1	MO-076	ADJ CHASSIS BANC	2
2	MO-073	ADJ CHASSIS TABLE A SPITER	2
3	MO-077	ADJ banc	2
4	MO-399	ASF PIED TABLE	2
5	P-4110	ASF POTEAU ALU A CHEVILLER	2
6	MO-400	ASF SUPPORT TOIT	2
7	MO-398	ASF TABLE	1
8	MO-401	ASF TOIT	2
9	QR-011	ECROU RELIEUR M8 L11	56
10	Q-027	INSERT 60x30	4
11	QV-149	TBHC M8X12	28
12	QV-007	TBHC M8X35	28
13	QV-008	TBHC M8X40	12
14	Q-005	chapeau poteau 90x90 alu	2
15	Q-008	cornière 35x35	16

	<i>Désignation :</i> TABLE SELF		<i>Matière :</i> HPL	
	<i>Référence :</i> ASF-HPL		<i>Finition :</i>	
<i>Date :</i> 22/11/2012	<i>Dessinateur :</i> MIOTES François		<i>Echelle :</i>	A4

RECTO

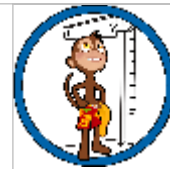
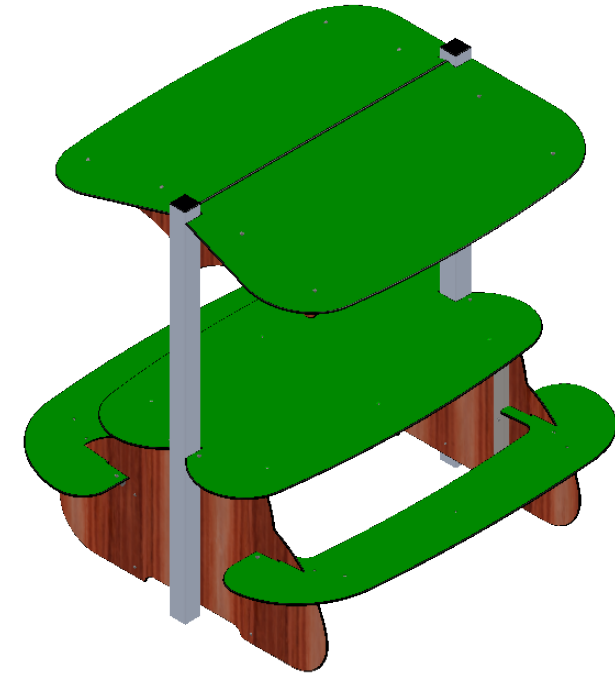

Adulte



6



 : Zone de sécurité (minimum normatif) = **** m²

 : Surface d'impact sur sol fuant = **** m²

 : Hauteur de chute libre = **** m

VERSO

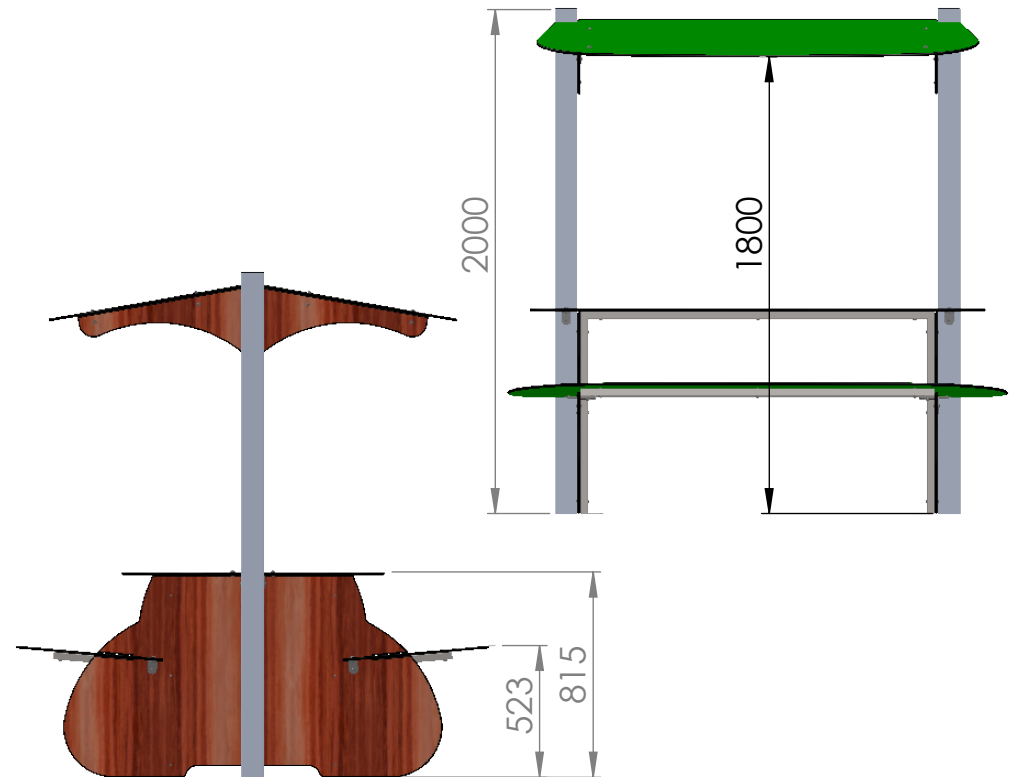
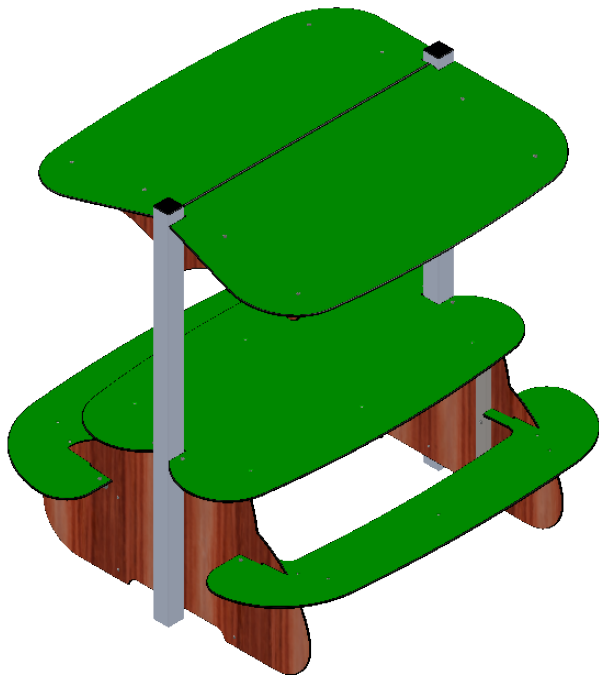

Désignation :

TABLE SELF

Matière :

HPL

Référence :

ASF-HPL

Finition :

Date : 31/08/2021

Dessinateur : MIOTES François

Echelle :

A4

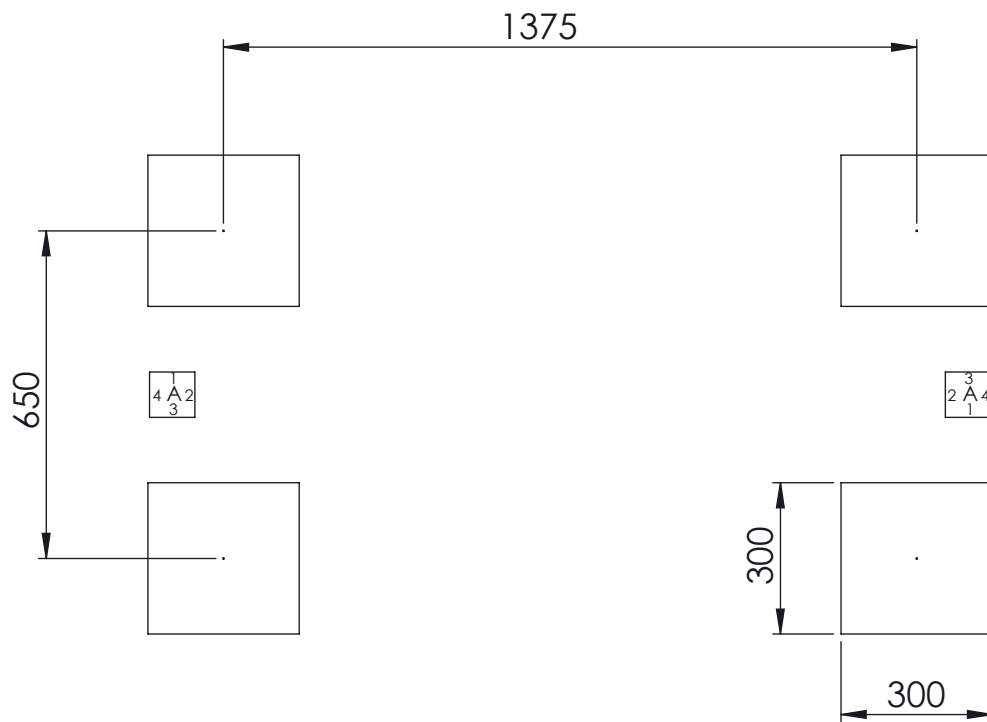

Scellement en 35 cm

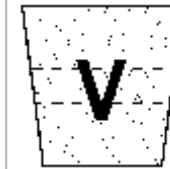

Volume de béton:

0.13 m³
(μ=250 kg/m³)

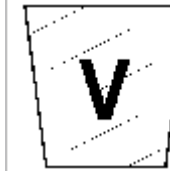

Déblais non foisonnés:

0.13 m³

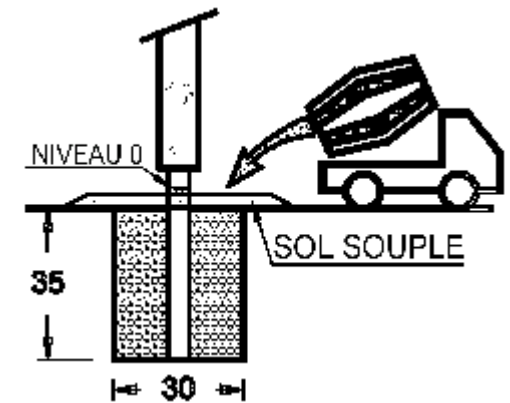

□ : 0.3 m x 0.6 m x 0.35 m

Scellement 75 Cm pour sol fluant

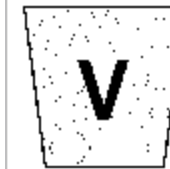

Volume de béton:

0.13 m³
(μ=250 kg/m³)

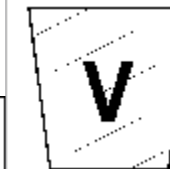

Déblais non foisonnés:

0.26 m³

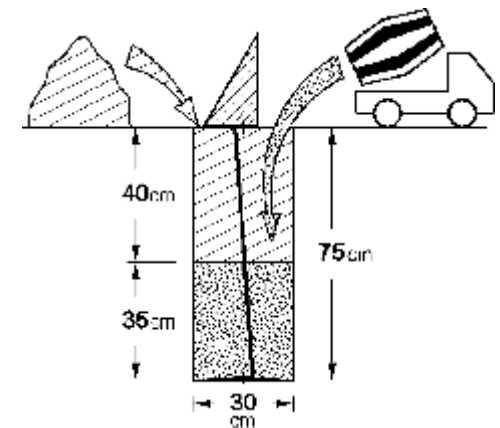

□ : 0.3 m x 0.6 m x 0.35 m

Montage des modules

Voir éclaté de montage

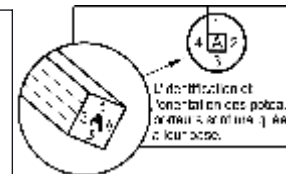

Désignation :

ASF-HPL fiche notice 2

Référence : ASF-HPL

Matière :

HPL

Finition :

PRÉSENTATION DE QUINCAILLERIE / CHEAP JEWELRY

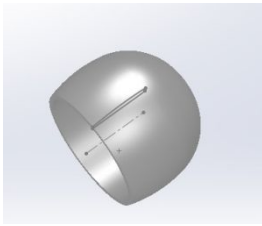

Q -003

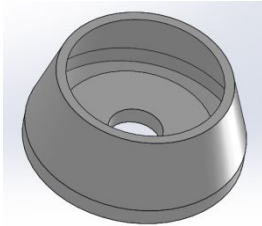

Q-010

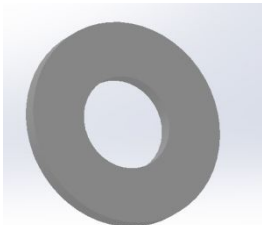

QR-002 / 003 / 005 / 006



QR-004

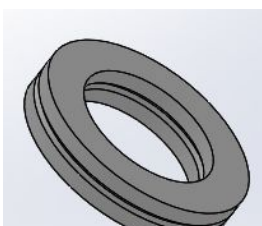

QR-007

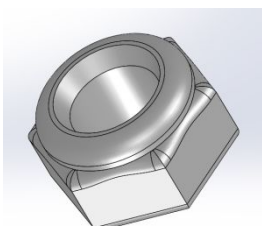

QE-002 / 003 / 004

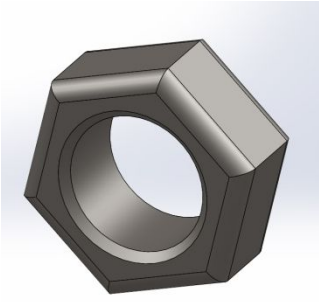

QE-005

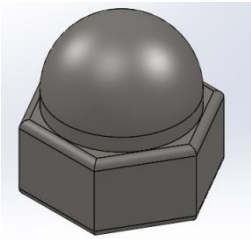

QE-009

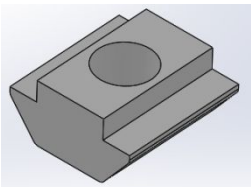

QE-006

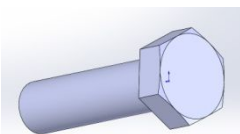

QV-101 / 074 / 013 / 014 / 020

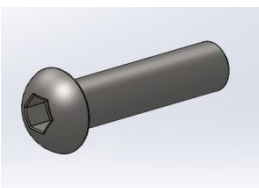

QV-006 / 007 / 008 / 009 / 010 / 011 / 075
/ 076 / 079 / 084 / 088

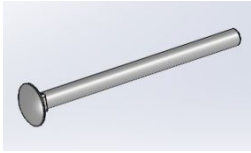

QV-048 / 049/ 050/ 051/ 052/ 053/ 054/
055/ 056/ 057/ 058/ 059/ 060/ 061/ 062/ 063/ 064/
065/ 066/ 067/ 068/ 069/ 070/ 071/ 072/ 073

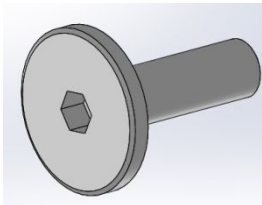

QV-109

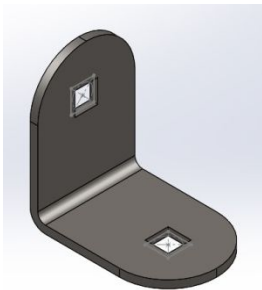

Q-008

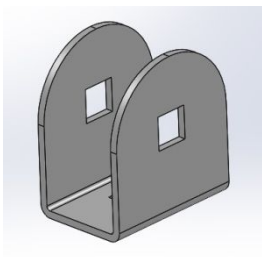

Q-002

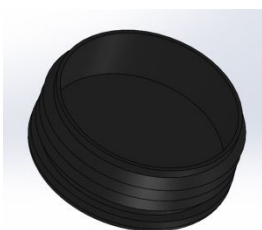

Q-030

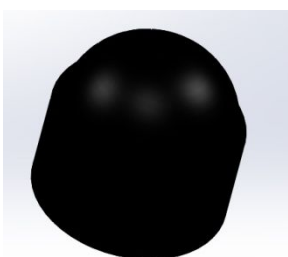

Q-349

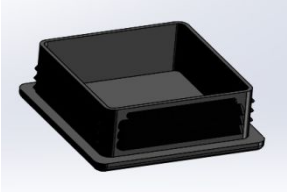

Q-005

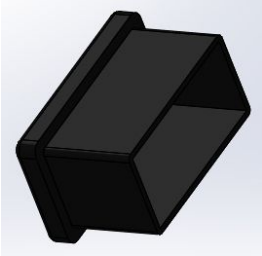

Q-022

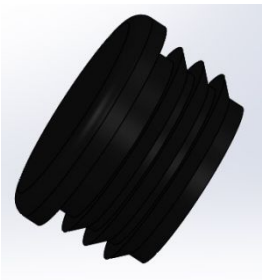

Q-028

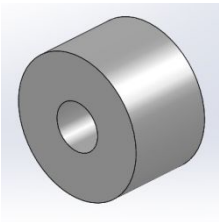

Q-016

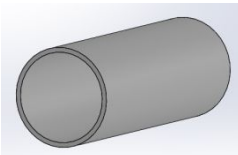

Q-011

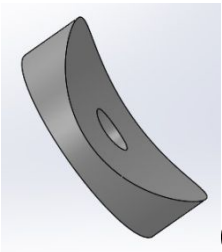

QR-001



KB-045

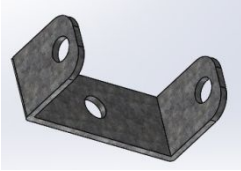

KB-046

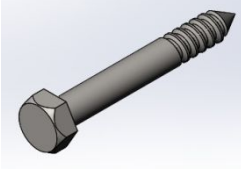

QV-127

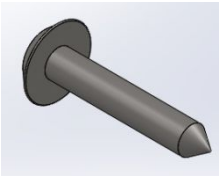

QV-001 / 125

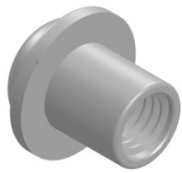
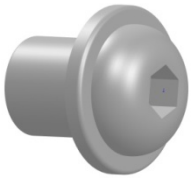

QR-011